

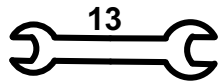

2 Osoby



13

Instrukcja montażu VELVET NEW 2DL-REC

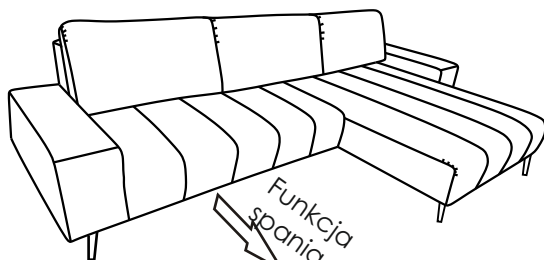

Układ prawy

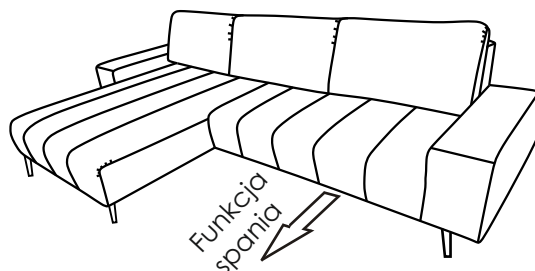

Układ lewy

Wykaz części:

H-150		H-155		Śruba sześciokątna	M8x24
A	x 3	B	x 6	M8x20	

Krok 1. Montaż stopek układ prawy

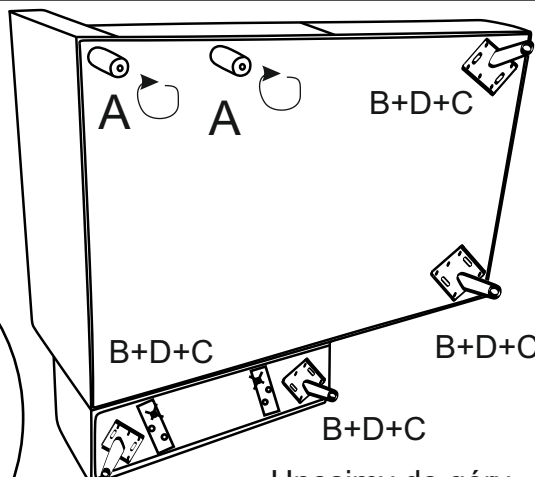
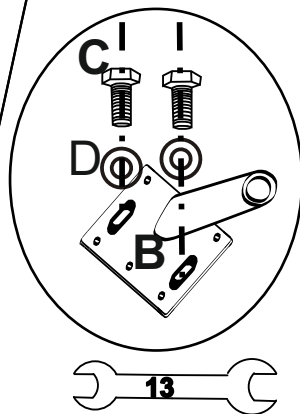
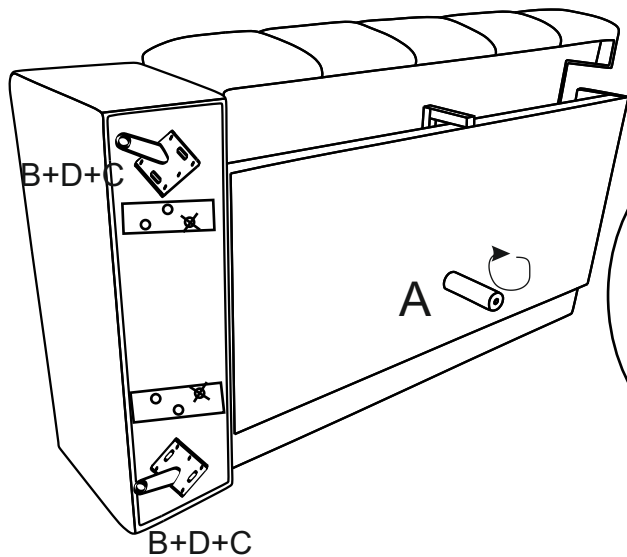

Unosimy do góry i stawiamy na nogi

90°

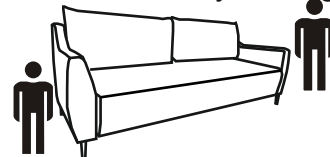

Krok 1. Montaż stopek układ lewy.

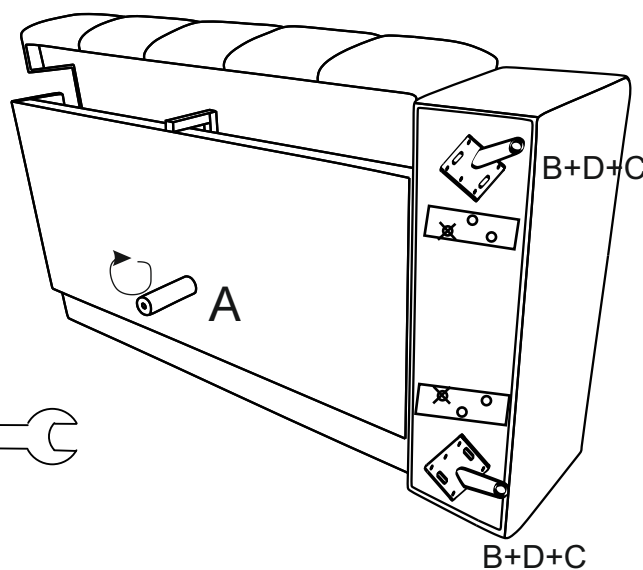
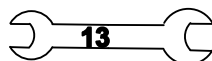
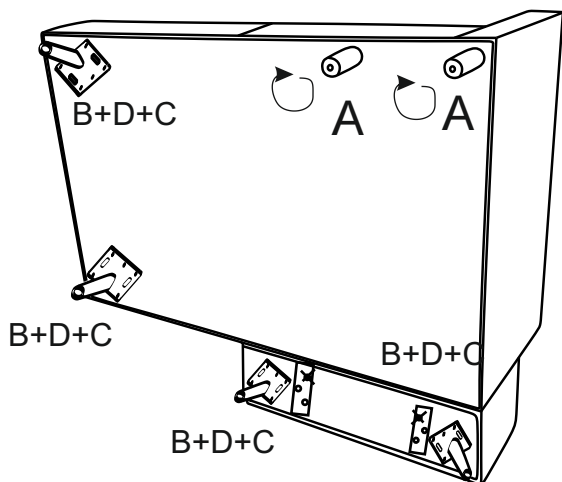

Unosimy do góry i stawiamy na nogi

90°

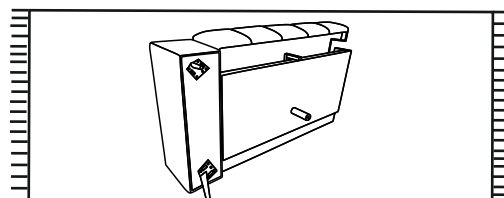
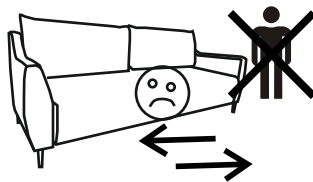
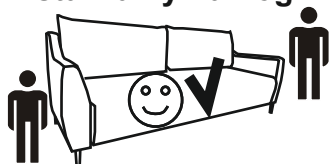



Instrukcja montażu VELVET NEW 2DL-REC

Krok 2. Łączenie narożnika

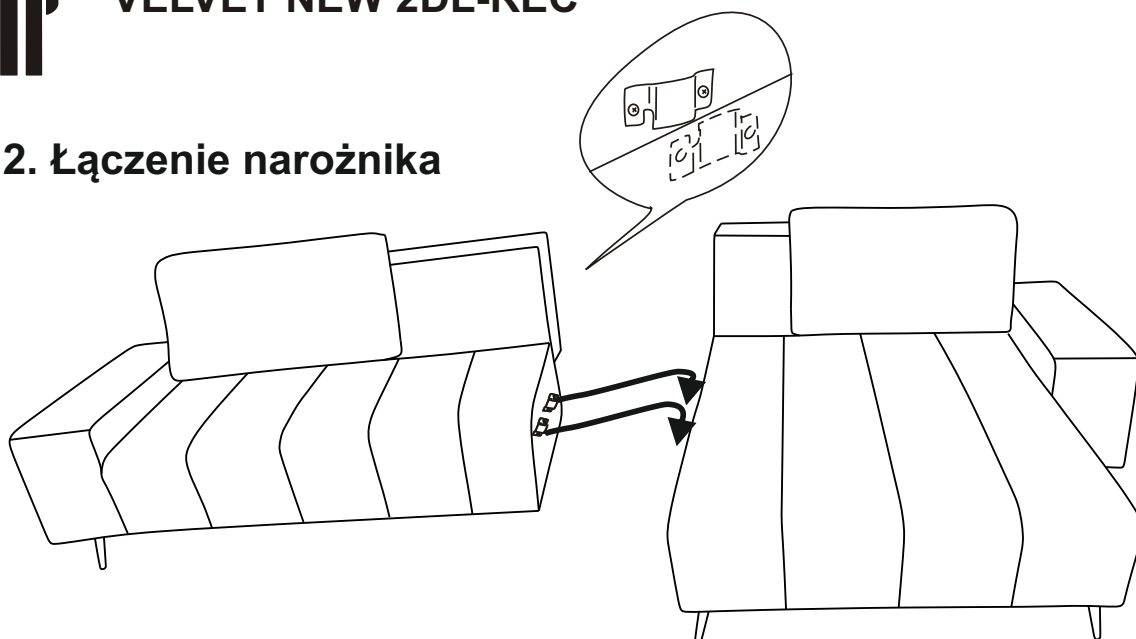

Krok 3. Regulacja wysokości siedziska.

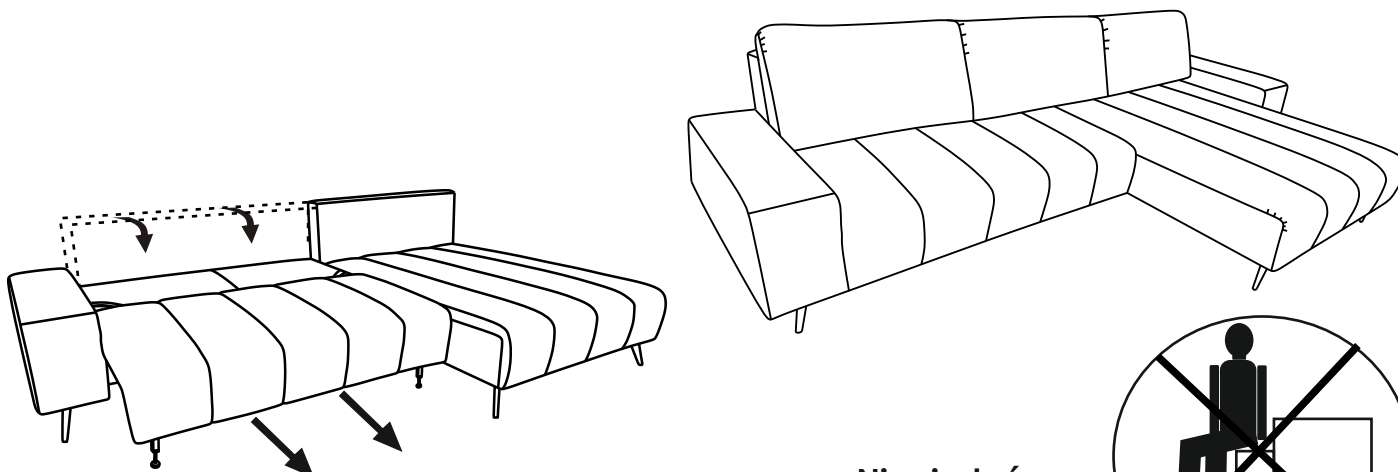
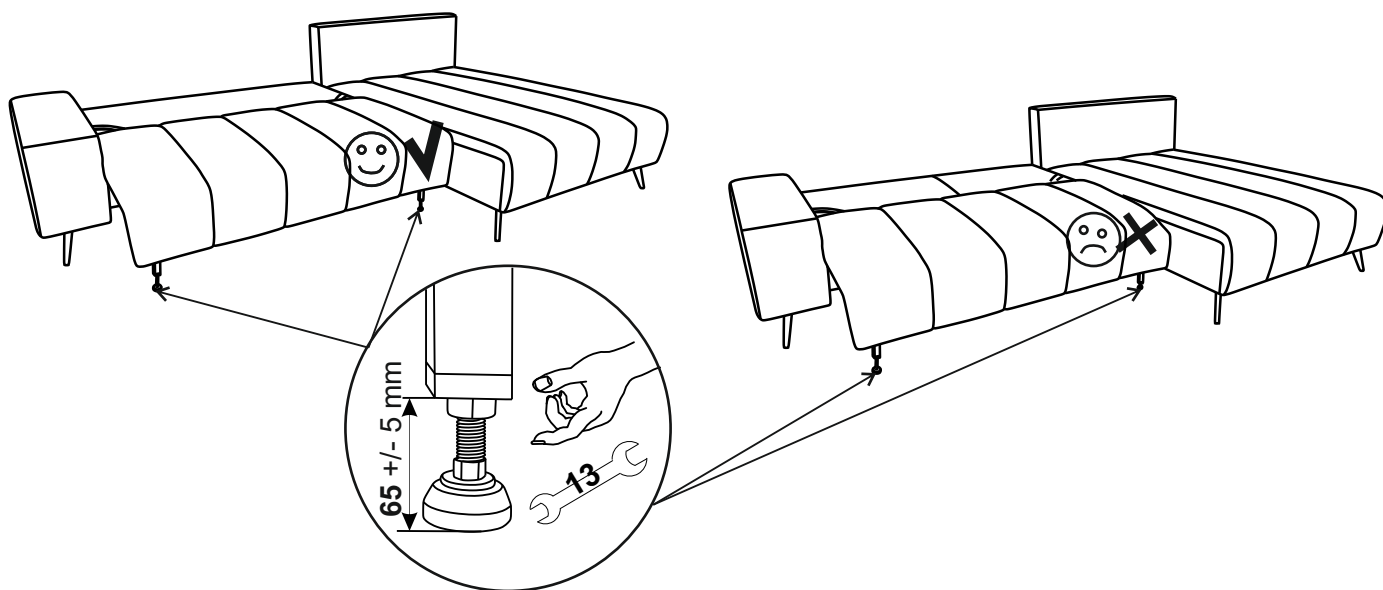

Nie siadać
na oparciu
i podłokietnikach

