

Instrukcja montażu
Assembling instruction
Montageanleitung
Montáž instrukce
Montáž inštrukcie

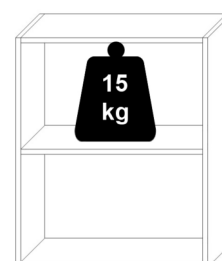

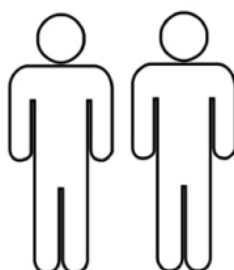

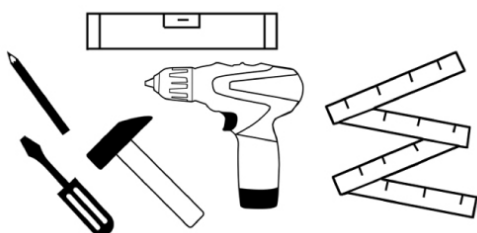

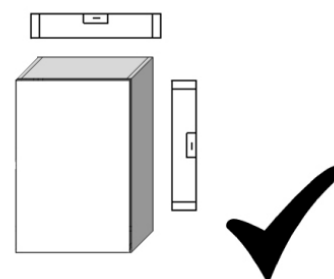
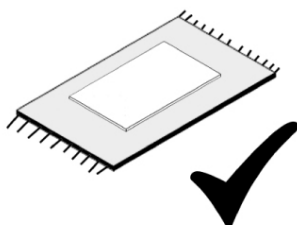
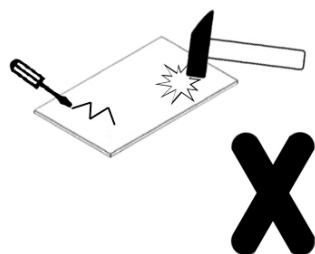
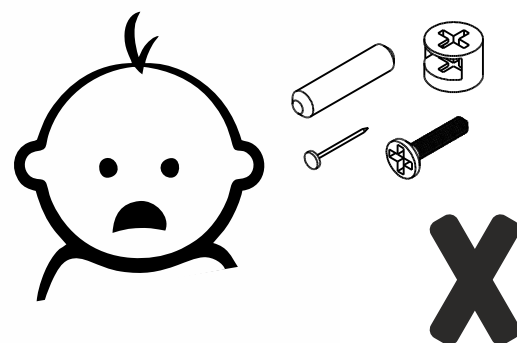
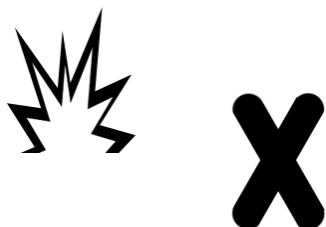
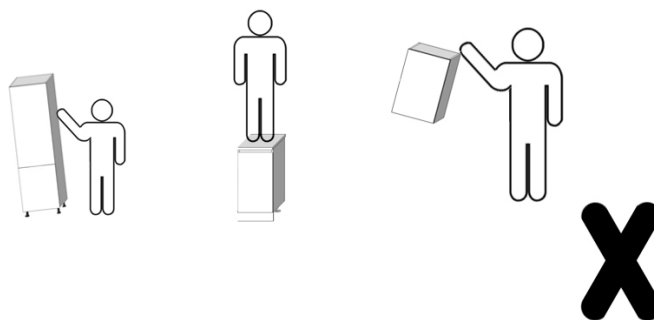
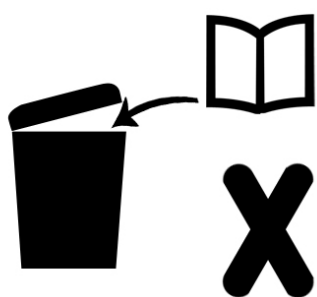
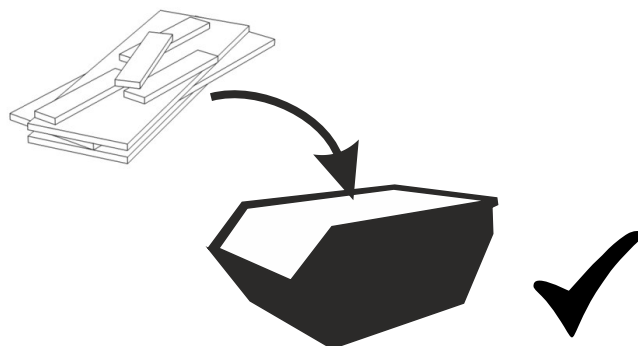
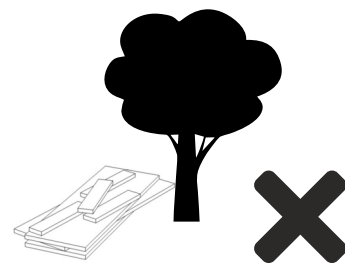
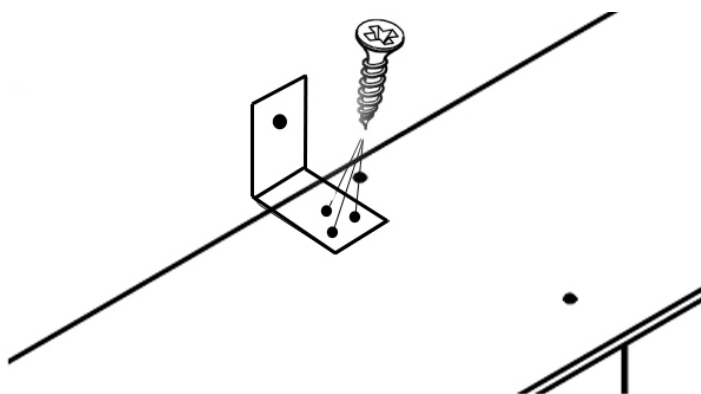

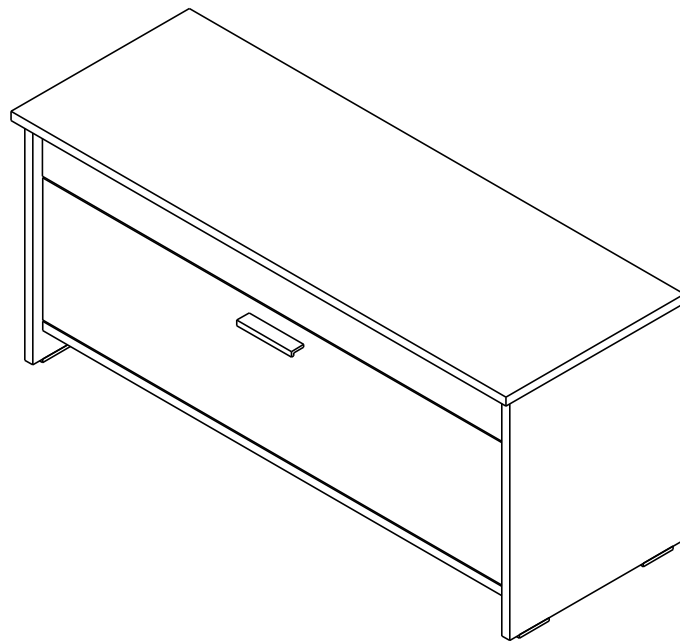

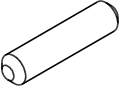

- Mebel należy ustawić na równej powierzchni, w razie potrzeby wypoziomować
The furniture should be placed on a flat surface and leveled if necessary.
Die Möbel sollten auf einer ebenen Fläche aufgestellt und bei Bedarf nivelliert werden
Nábytek by měl být umístěn na rovný povrch a v případě potřeby vyrovnán
Nábytok by mal byť umiestnený na rovnom povrchu a v prípade potreby vyrovnaný
- Mebel musi znajdować się w suchym pomieszczeniu z dala od źródła ciepła oraz niekorzystnych warunków atmosferycznych (światło słoneczne, wody itp.)
The furniture must be placed in a dry room away from heat sources and unfavorable weather conditions (sunlight, water, etc.)
Die Möbel müssen in einem trockenen Raum, entfernt von Wärmequellen und ungünstigen Wetterbedingungen (Sonnenlicht, Wasser usw.) aufgestellt werden.
Nábytek musí být umístěn v suché místnosti, daleko od zdrojů tepla a nepříznivých povětrnostních podmínek (sluneční světlo, voda atd.)
Nábytok musí byť umiestnený v suchej miestnosti, mimo zdrojov tepla a nepriaznivých poveternostných podmienok (slnečné svetlo, voda a pod.)
- Maksymalny udźwig mebla to 15kg
The maximum load capacity of the furniture is 15 kg.
Die maximale Belastbarkeit der Möbel beträgt 15 kg
Maximální nosnost nábytku je 15 kg
Maximálna nosnosť nábytku je 15 kg
- Mebel koniecznie należy przytwierdzić do ściany
The furniture must be attached to the wall.
Die Möbel müssen an der Wand befestigt werden
Nábytek musí být připevněn ke stěně
Nábytok musí byť pripevnený k stene
- Nie należy przesuwac mebla. W celu przeniesienia należy unieść całą bryłę podtrzymując elementy konstrukcyjne
Do not move the furniture. In order to move it, you must lift the entire piece while supporting the structural elements.
Bewegen Sie die Möbel nicht. Um sie zu bewegen, heben Sie die gesamte Struktur an und stützen Sie die Strukturelemente ab
Nepřemisťujte nábytek, abyste jej mohli přesunout, zvedněte celou konstrukci, podepírající konstrukční prvky
Nehýbte nábytkom, aby ste ho mohli presunúť, zdvihnite celú konštrukciu, podopierajúc konštrukčné prvky
- Czyszczenie wykonywać tylko wilgotna szmatką
Clean only with a damp cloth.
Nur mit einem feuchten Tuch reinigen
Čistěte pouze vlhkým hadříkem
Čistite iba vlhkou handričkou

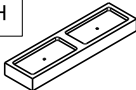

ELA

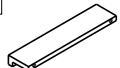
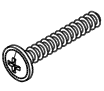

<p>A</p>  <p>4</p>	<p>B</p>  <p>24</p>	<p>C</p>  <p>24</p>	<p>D</p>  <p>1</p>	<p>E</p> <p>3,5x16</p>  <p>12</p>	<p>F</p> <p>4x16</p>  <p>8</p>
<p>G</p>  <p>1</p>	<p>H</p>  <p>4</p>	<p>J</p>  <p>35</p>	<p>K</p>  <p>5</p>	<p>L</p>  <p>1</p>	<p>M</p>  <p>2</p>
<p>N</p>  <p>2</p>	<p>P</p>  <p>2</p>	<p>R</p>	<p>S</p>	<p>T</p>	<p>U</p>

